

Fittings for accurate measurements



Versatile real time and wireless systems
for measurements in all kinds of food containers



Table of contents

Fittings for accurate measurements	3
Calculation of probe and gland specifications	5
Normal and vacuum sealed cans	6
Aluminium and plastic containers	7
Glass jars with metal lids	8
Plastic and aluminium pouches	9
Plastic and aluminium doypacks and flat pouches	10
Small plastic and aluminium containers	11
Filled metal containers	12
Glass and plastic bottles	13
Retortable cartons	14
Direct measurements in food particulates	15
Heat penetration multipoint probe	16
Real time container deflection with E-Val Flex	17
Real time pressure with E-Val Flex	18
Real time rotation measurements with E-Val Flex	19
Container pressure with TrackSense® Pro	20
Temperature and relative humidity (RH%) in smokehouses with... ..	21
Internal fittings	22
Internal temperature fittings for cans, jars, trays, bottles, retortable cartons	23
Internal temperature fittings for flat pouches and doypacks	24
Internal pressure fittings for all kinds of containers, cans, jars, trays, bottles... ..	25
Can rotation speed in continous cooker-coolers and hydrostats	26
Instructions for perforating and embossing the containers	27
Instructions for perforating the containers	29
Protective sleeves for the TrackSense® Pro loggers	30
ID labels for Ellab thermocouples and TrackSense® Pro sensors	31



Fittings for accurate measurements

There are many factors that can impact on the efficacy of a thermal process but one of the main considerations in the development of processes for heat preserved foods is the acquisition of accurate time/temperature profiles. The main reasons for this are:

- Safety – ensuring that microbial stability has been achieved and there is no risk of food poisoning or food spoilage
- Optimisation – reducing process times to increase production throughput and minimise energy costs
- Improvement of quality – optimisation of vitamin and protein retention, and product sensorial qualities
- Process validation – providing documentation to demonstrate compliance with regulations for authorities, FDA/USDA, EC, customers, ISO9000, HACCP, etc.

The validation procedure encompasses many aspects with the process vessel and product both needing detailed study. In both cases it is important to find the cold zone at which the slowest heat transfer will be applied. Three phases of tests should be considered:

- Temperature distribution – temperature mapping within a fully loaded process vessel to investigate performance against a control programme and identify the cold zone.
- Cold point determination – multiple measurements within a product container to find the slowest heating point within the product. This will be product and packaging dependent.
- Heat penetration – replicate measurements with temperature measurement devices located at the position identified within the cold point tests.

All of the above phases are focused on identifying the worst case conditions to which a product would be exposed, with the lowest temperatures and slowest heat transfer leading to the lowest microbial reduction. It is therefore crucial that the temperature measurement devices are of high accuracy and reliability. A systematic or experimental error of 1°C in a temperature measurement system at the sterilisation reference temperature of 121.1°C would lead to a corresponding error of 26% in the calculated F_0 sterility value.

It is therefore important that the correct equipment is applied for a given validation. We have developed a large selection of probes, sensors, packing glands, and tools which are available for correct mounting in many styles and designs of container. The range of fittings available is being continually expanded and improved with the following parameters taken into consideration:



- **Correct positioning of the measuring point**

It is very important that the packing gland and probe are correctly positioned in the “cold spot”. If this is not obtained it can result in “false” measurements, risking high Fo/Po-Values.

- **Elimination of steam and water ingress**

It is very important that the packing gland and the probe are mounted so as to maintain the integrity of the container and ensure that water/steam ingress to the measuring point cannot occur leading to false data and high Fo/Po values.

- **Minimizing risks of heat conduction**

It is recommended that the probe and gland are mounted from the side of the container with the longest distance to the “cold spot” so that heat conduction from the water/steam is avoided. Even if the probe/gland is as small as possible and made of materials with the lowest conductivity there will always be a risk for heat conduction.

- **Minimizing the probe assembly inside the container**

It is very important that the probe and gland are as small as possible so that the impact on the internal environment (product) of the container, including the headspace, is minimised. This is especially important for products that receive a rotary process where the movement of the headspace will be a critical factor in the rate of heat transfer.

If it is a mixed product in liquid it is important the biggest piece of solid is positioned at the measuring point, and that the probe assembly is mounted so it is not preventing the other solid pieces to move freely. The reference container must be as close to the “normal” containers as possible, otherwise the heat transfer profile will no longer be representative for the entire batch.



Calculation of probe and gland specifications

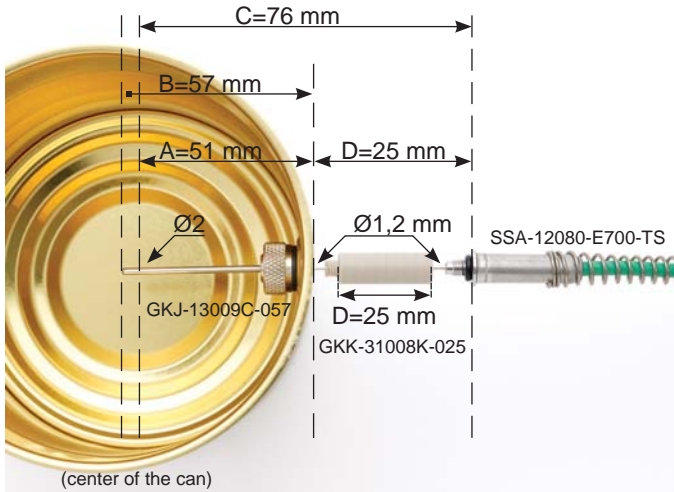

The picture shows an example of how to calculate the measuring depth for all kinds of containers.

A

The measuring depth in which the measuring point - "cold spot" has to be situated.

B

The packing gland has to be 6 mm longer than the measuring depth, corresponding to the size of the sealings of the gland and the probe. The length of the gland is specified in the last three characters of the type designation - GKJ-13009C-057.

C

In this case the probe electrode length is 80 mm, specified in the last three characters of the type designation - SSA-12080-G700-TS. Because of the size of the thermojunction and the sealing of same, the measuring point is situated 4 mm from tip.

D

As the probe electrode is longer than the GKJ-C gland, a space bar of 25 mm is screwed in between the probe bushing and gland. The three last characters of the type designation specifies the length - GKK-31008K-025. A probe with 55 mm electrode can be used directly without using a space bar.

The GKJ Packing Gland is developed for mounting with the o-ring positioned inside the container, so it is flush with the outside wall of the container. This ensures that the container can be filled and sealed in industrial machinery.

If this is not a critical parameter the o-ring can also be positioned outside the container still taking the position of the measuring point in the cold spot into consideration.

Normal and vacuum sealed cans



Packing gland type GKJ

Make a hole in the can with the can punch TC89 or TC40S/TC41 (see instructions for perforating and embossing the containers).

Disassemble the GKJ packing gland (1).

Introduce the bushing (2) into the can and ensure that the measuring point is correctly positioned in the "cold spot".

Place the o-ring (3) on the bushing (2) from the inside of the can.

Screw on and fasten the fingernut (4) from the inside of the can.

The can can now be filled and sealed in the sealing machine.

The logger is started up in the reader station.

The sensor is introduced and if necessary a GKK-K space bar (5) can be used.

If a double sensor is used both product and ambient temperature can be measured in the same position at the same time.

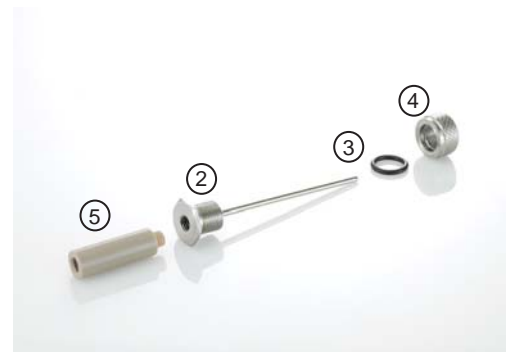

Configuration

SSA12xxxE700TS Sensor

- ① GKJ13009Cxxx Packing gland
- ⑤ GKK31008Kxxx Space bar (optional)

TSP 2 mm

- GKJ21009Cxxx Packing gland
- GKK31008Kxxx Space bar (optional)

TSP Mini 2.5 mm

- GKJ26009Cxxx Packing gland
- GKK31008Kxxx Space bar (optional)

TSP 3 mm

- GKJ31009Cxxx Packing gland
- GKK31008Kxxx Space bar (optional)

Spare part list

- | | | | |
|------------------------------------|----------------------------------|----------------------------------|----------------------------------|
| ③ GKJ-U O-ring | GKJ-U O-ring | GKJ-U O-ring | GKJ-U O-ring |
| ④ GKJ-J Stainless steel finger nut | GKJ-J Stainless steel finger nut | GKJ-J Stainless steel finger nut | GKJ-J Stainless steel finger nut |

When ordering sensors, packing glands and space bars please replace xxx with the length(s) needed.

Aluminium and plastic containers



Packing gland type GKJ

Make a hole in the container with the can punch TC89 or TC40S/TC41 (see instructions for perforating and embossing the containers).

Disassemble the GKJ packing gland (1).

With parallel sides

Introduce the bushing (2) into the can and ensure that the measuring point is correctly positioned in the "cold spot".

Place the O-ring (3) on the bushing (2) from the inside.

Screw on and fasten the fingernut (4) from the inside of the can.

With unparallel sides

Introduce the bushing (2) with a wedge washer (6) into the container and ensure that the measuring point is correctly positioned in the cold spot.

Place the other wedge washer (6) on the bushing from the inside of the container. Screw on and fasten the fingernut (4) from the inside of the container. The container can now be filled and sealed in the sealing machine.

The logger is started up in the reader station. The sensor is introduced and if necessary a GKK-K space bar (5) can be used. If a double sensor is used both product and ambient temperature can be measured in the same position at the same time.



Configuration

SSA12xxxE700TS Sensor

- ① GKJ13009Cxxx Packing gland
- ⑤ GKK31008Kxxx Space bar (optional)
- ⑥ GFJ-K Wedge washers

TSP 2 mm

- GKJ21009Cxxx Packing gland
- GKK31008Kxxx Space bar (optional)
- GFJ-K Wedge washers

TSP Mini 2.5 mm

- GKJ26009Cxxx Packing gland
- GKK31008Kxxx Space bar (optional)
- GFJ-K Wedge washers

TSP 3 mm

- GKJ31009Cxxx Packing gland
- GKK31008Kxxx Space bar (optional)
- GFJ-K Wedge washers

Spare part list

- | | | | |
|------------------------------------|----------------------------------|----------------------------------|----------------------------------|
| ③ GKJ-U O-ring | GKJ-U O-ring | GKJ-U O-ring | GKJ-U O-ring |
| ④ GKJ-J Stainless steel finger nut | GKJ-J Stainless steel finger nut | GKJ-J Stainless steel finger nut | GKJ-J Stainless steel finger nut |

When ordering sensors, packing glands and space bars please replace xxx with the length(s) needed.

Glass jars with metal lids



Packing gland type GKJ

Make a hole in the lid with the can punch TC89 or TC40S/TC41 (see instructions for perforating and embossing the containers).

Disassemble the GKJ packing gland (1).

Introduce the bushing (2) into the lid and ensure that the measuring point is correctly positioned in the "cold spot".

Place the o-ring (3) on the bushing (2) from the inside of the lid.

Screw on and fasten the fingernut (4) from the inside of the lid. The jar can now be filled and sealed.

The logger is started up in the reader station.

The sensor is introduced and if necessary a GKK-K space bar (5) can be used.

If a double sensor is used both product and ambient temperature can be measured in the same position at the same time.

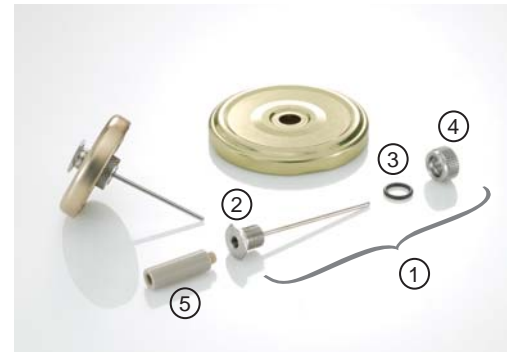

Configuration

SSA12xxxE700TS Sensor

- ① GKJ13009Cxxx Packing gland
- ⑤ GKK31008Kxxx Space bar (optional)

TSP 2 mm

- GKJ21009Cxxx Packing gland
- GKK31008Kxxx Space bar (optional)

TSP Mini 2.5 mm

- GKJ26009Cxxx Packing gland
- GKK31008Kxxx Space bar (optional)

TSP 3 mm

- GKJ31009Cxxx Packing gland
- GKK31008Kxxx Space bar (optional)

Spare part list

- | | | | |
|------------------------------------|----------------------------------|----------------------------------|----------------------------------|
| ③ GKJ-U O-ring | GKJ-U O-ring | GKJ-U O-ring | GKJ-U O-ring |
| ④ GKJ-J Stainless steel finger nut | GKJ-J Stainless steel finger nut | GKJ-J Stainless steel finger nut | GKJ-J Stainless steel finger nut |

When ordering sensors, packing glands and space bars please replace xxx with the length(s) needed.

Plastic and aluminium pouches

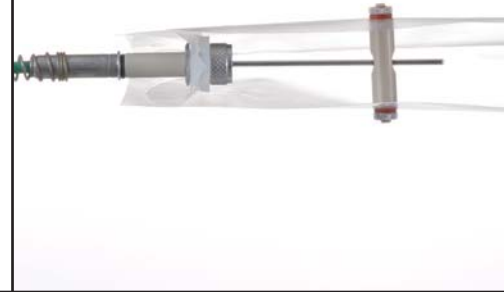

Packing gland type GKJ

Make a 8mmØ hole in the pouch with the cutting tool type TC42 (see instructions for perforating and embossing the containers).

Disassemble the GKJ packing gland (1).

Make two holes on each side of the pouch of approximately 2mmØ. The height/thickness of the filled pouch is measured and a fitting GEM-K distance piece (6) is mounted as shown on photo.

Introduce the bushing (2) with one silicone washer (7) into the container, and then place the other silicone washer (7) and the finger nut (4) on the gland from the inside.

The end of the gland is via the centerhole of the GEM-K (6) placed in the “cold spot” of pouch, and the fingernut (4) is fastened by hand so it is tight. The two nuts of the GEM-K are also fastened by hand until they are tight.

The container can now be filled and sealed in the sealing machine. The logger is started up in the reader station.

The sensor is introduced and if necessary a GKK-K space bar (5) can be used. If a double sensor is used both product and ambient temperature can be measured in the same position at the same time.

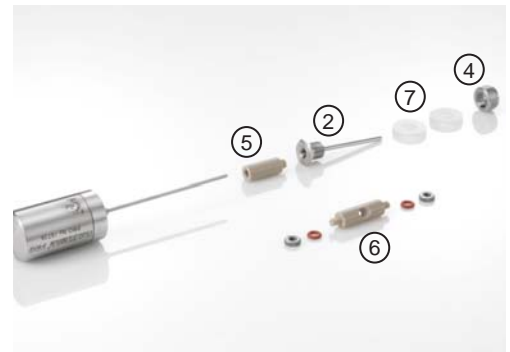
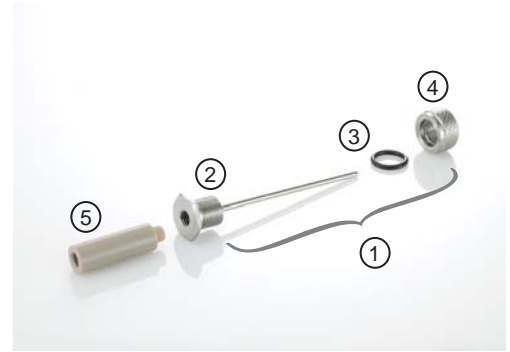

Configuration

SSA12xxxE700TS Sensor

- ① GKJ13009Cxxx Packing gland
- ⑤ GKK31008Kxxx Space bar (optional)
- ⑦ GFJ-S Silicone rubber washer
- ⑥ GEM26008Kxxx Distance piece

TSP 2 mm

- GKJ21009Cxxx Packing gland
- GKK31008Kxxx Space bar (optional)
- GFJ-S Silicone rubber washer
- GEM26008Kxxx Distance piece

TSP Mini 2.5 mm

- GKJ26009Cxxx Packing gland
- GKK31008Kxxx Space bar (optional)
- GFJ-S Silicone rubber washer
- GEM26008Kxxx Distance piece

TSP 3 mm

- GKJ31009Cxxx Packing gland
- GKK31008Kxxx Space bar (optional)
- GFJ-S Silicone rubber washer
- GEM26008Kxxx Distance piece

Spare part list

- | | | | |
|------------------------------------|----------------------------------|----------------------------------|----------------------------------|
| ③ GKJ-U O-ring | GKJ-U O-ring | GKJ-U O-ring | GKJ-U O-ring |
| ④ GKJ-J Stainless steel finger nut | GKJ-J Stainless steel finger nut | GKJ-J Stainless steel finger nut | GKJ-J Stainless steel finger nut |

When ordering sensors, packing glands and space bars please replace xxx with the length(s) needed.

Plastic and aluminium doypacks and flat pouches

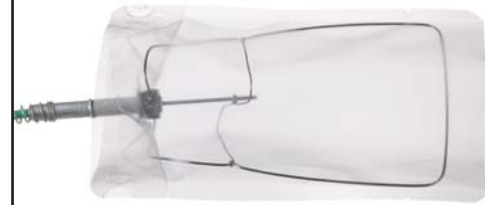

TPJ stainless steel frame

A frame which is manufactured exactly for the dimensions of the pouch is inserted into the pouch. The pouch has to be sent to Ellab. The frame is in the middle furnished with a “crossing wire” fitting the thickness of the pouch for fixating the sensor, and thus avoiding movement of the sensor touching the wall of the pouch.

An 8mm Ø hole is punched either from bottom or side (what is most convenient) in which a packing gland is mounted, also fixating the frame inside the pouch. Disassemble the GKJ packing gland (1). The bushing (2) is introduced into the container, the o-ring (3) is positioned on the thread from the inside and the gland is screwed into the thread (4) of the frame.

The “crossing wire” has a hole through in which the needle of the packing gland is inserted, securing fixation of the sensor in the “cold spot”. The pouch can now be filled, and if a mixed product the part with the slowest heat transfer can be positioned at the measuring points (meat balls, fish etc.). Then the pouch can be sealed. The logger and temperature sensor(s) are started up in the reader station.

The sensor is introduced and if necessary a GKK-K space bar (5) can be used.

If a double sensor is used both product and ambient temperature can be measured in the same position at the same time.

The advantage with this method is that there is a minimum of probe assembly inside the pouch, minimizing risks of heat conduction and securing the reference container is as close to the “normal” containers as possible, because otherwise the heat transfer profile will no longer be representative for the entire batch.

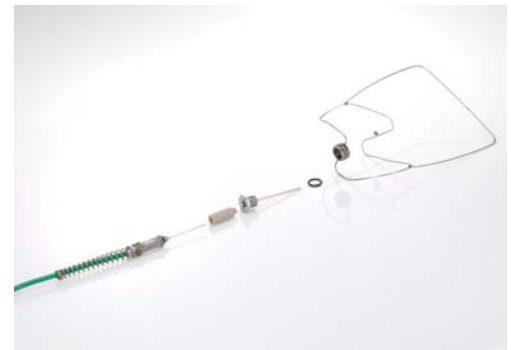
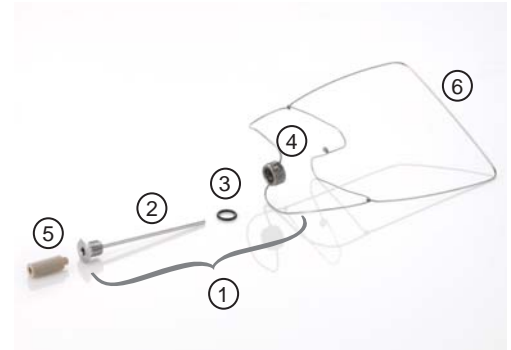

Configuration

SSA12xxxE700TS Sensor	TSP 2 mm	TSP Mini 2.5 mm	TSP 3 mm
⑥ TPJ Stainless steel frame	TPJ Stainless steel frame	TPJ Stainless steel frame	TPJ Stainless steel frame
① GKJ13009Cxxx Packing gland	GKJ21009Cxxx Packing gland	GKJ26009Cxxx Packing gland	GKJ31009Cxxx Packing gland
⑤ GKK31008Kxxx Space bar (optional)	GKK31008Kxxx Space bar (optional)	GKK31008Kxxx Space bar (optional)	GKK31008Kxxx Space bar (optional)

Spare part list

③ GKJ-U O-ring	GKJ-U O-ring	GKJ-U O-ring	GKJ-U O-ring
④ GKJ-J Stainless steel finger nut	GKJ-J Stainless steel finger nut	GKJ-J Stainless steel finger nut	GKJ-J Stainless steel finger nut

When ordering sensors, packing glands and space bars please replace xxx with the length(s) needed.

Small plastic and aluminium containers



Packing gland type GEJ

Make a 4mmØ hole in the container.

Disassemble the GEJ packing gland (1).

Mount one o-ring (3) on the bushing (2) and introduce the bushing into the container.

Place the other o-ring (3) on the bushing (2) from the inside.

Screw on and fasten the fingernut (4) from the inside of the container. The container can now be filled and sealed, and a piece of tape covering the hole can prevent the product dripping out.

The logger is started up in the reader station.

The sensor can now be introduced, and if necessary a GKK-K space bar (5) can be used. Ensure that the measuring point is correctly positioned in the "cold spot".

If a double sensor is used both product and ambient temperature can be measured in the same position at the same time.



Configuration

SSA12xxxE700TS Sensor

- ① GEJ13040C Packing gland
- ⑤ GKK31008Kxxx Space bar (optional)

TSP Mini 2.5 mm

- GEJ26040C Packing gland
- GKK31008Kxxx Space bar (optional)

TSP 3 mm

- GEJ31040C Packing gland
- KK31008Kxxx Space bar (optional)

Spare part list

- | | | |
|---------------------|-------------------|-------------------|
| ④ GEJ-J Finger nuts | GEJ-J Finger nut | GEJ-J Finger nut |
| ③ GEJ37007U O-rings | GEJ37007U O-rings | GEJ37007U O-rings |

When ordering sensors, packing glands and space bars please replace xxx with the length(s) needed.

Filled metal containers



Packing gland type HUJ

Mark the container where you want the HUJ-C gland to be fitted.

Make a hole in the container with the TC25 perforation tool (6) and a hammer.

Place the HUJ-C (1) mounted with silicone rubber washer (3) in the TC26 spanner (7) and screw it into the hole.

Screw until it is tight, but be careful not to screw too tight.

The logger is started up in the reader station.

The sensor is introduced and if necessary a GKK-K space bar (5) can be used.

If a double sensor is used both product and ambient temperature can be measured in the same position at the same time.



Configuration

SSA12xxxE700TS Sensor

- ① HUJ13035C005 Packing gland
- ⑤ GKK31008Kxxx Space bar (optional)

TSP 2-3 mm

- HUJ31035C005 Packing gland
- GKK31008Kxxx Space bar (optional)

Spare part list

- ⑥ TC25 Perforation tool
- ⑦ TC26 Spanner
- ③ HUJ-S Silicone rubber washer
- TC25 Perforation tool
- TC26 Spanner
- HUJ-S Silicone rubber washer

When ordering sensors, packing glands and space bars please replace xxx with the length(s) needed.

Glass and plastic bottles



Packing gland type GVK

The xxx in the type designation has to be replaced with the neck diameter and a sample of the bottle has to be sent to Ellab.

Disassemble the GVK packing gland (1).

After filling the bottle the lower part of the gland (4) (with an outer thread) is pressed around the bottle neck.

The upper part (2) of the gland, with inner thread and silicone washer (3) inside is screwed on the lower part (4) until it is tight.

The logger is started up in the reader station.

The sensor is introduced and if necessary a GKK-K space bar (5) can be used.

If a double sensor is used both product and ambient temperature can be measured in the same position at the same time.



Configuration

SSA12xxxE700TS Sensor

TSP 2-3 mm

① GVK42xxxC000 Packing gland

GVK42xxxC000 Packing gland

⑤ GKK31008Kxxx Space bar (optional)

GKK31008Kxxx Space bar (optional)

Spare part list

③ GVK-S Silicone rubber washer

GVK-S Silicone rubber washer

When ordering sensors, packing glands and space bars please replace xxx with the length(s) needed.

Retortable cartons

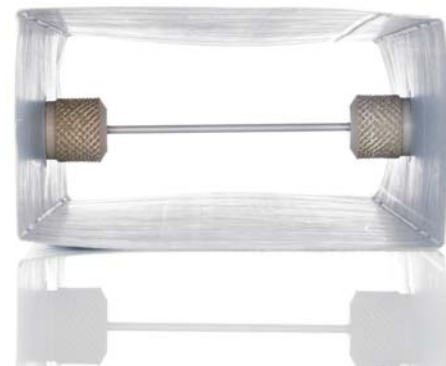

Packing gland type RECART

A special packing gland (1) is fitted from wall to wall of the carton, securing that the measuring point will not move during processing.

Disassemble the RECART packing gland (1).

Make two 8mmØ holes with the TC42 cutting tool on each side of the carton.

The bushing (2) is screwed into the hole of one side of the carton.

The other bushing (3) with a stainless steel tube is screwed into the hole of the other side and the stainless steel tube is fitted into the first bushing (2).

The o-rings must be positioned inside the carton and the two nuts on bushings (2) (3) are fastened by hand until they are tight.

The container can now be filled and sealed in the sealing machine.

The logger is started up in the reader station.

The sensor is introduced and if necessary a GKK-K space bar (5) can be used.

If a double sensor is used both product and ambient temperature can be measured in the same position at the same time.

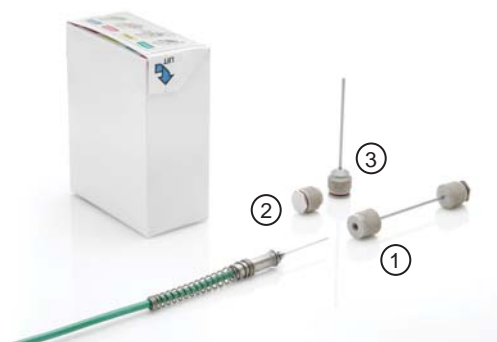

Configuration

	SSA12xxxE700TS Sensor	TSP 2 mm	TSP Mini 2.5 mm	TSP 3 mm
①	RECART Pack. gl. for 1.2mmØ probe	RECART Pack. gl. for 2mmØ sensors	RECART Pack. gl. for 2.5mmØ sensors	RECART Pack. gl. for 3mmØ sensors
⑤	GKK31008Kxxx Space bar (optional)	GKK31008Kxxx Space bar (optional)	GKK31008Kxxx Space bar (optional)	GKK31008Kxxx Space bar (optional)

When ordering sensors, packing glands and space bars please replace xxx with the length(s) needed.

Direct measurements in food particulates

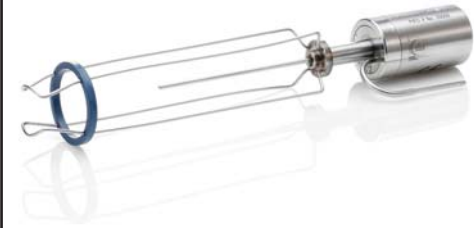

Sausages (Hot dogs)

Fixture type HBJ-120

This packing gland is developed for all kind of sausages in sterilization, pasteurisation, cooling and freezing. The sausage is positioned in the fixture and afterwards the sensor is positioned so the measuring point is in the “cold spot”. It can be used for both batch and continuous processing.



Pasta (Ravioli)

Fixture type HBJ-Q

This packing gland is developed for all kind of ravioli pieces and can also be used for other kinds of meat balls, chunks, fish etc., in sterilization, pasteurisation, cooling and freezing. The pasta is positioned in the fixture and afterwards the sensor is positioned so the measuring point is in the “cold spot”. It can be used for both batch and continuous processing.



Shrimp pre-cooking

Fixture type HBK70000Q

This packing gland is developed for all kind of shrimps in sterilization, pasteurisation, cooling and freezing. The shrimp is positioned in the fixture and afterwards the sensor is positioned so the measuring point is in the “cold spot”. It can be used for both batch and continuous processing.





Heat penetration multipoint probe

Type SD4-30110-G700-ST multipoint probe Packing gland type GFJ-36009C-000

The above are designed for measurements in all kinds of containers. On demand the SD4 probes can be delivered with other specifications corresponding to the size of the container and the product.

Make a hole in the container. Non-flexible with TC89 or TC40S/41, flexible with TC42.

Disassemble the GFJ packing gland (1).

Introduce the bushing (2) mounted with an o-ring or a washer (please see below) into the hole, and place the other o-ring or washer on the bushing from the inside of the container.

Non-flexible containers: 2 pieces GFJ-U (3) o-rings are used.

Thin flexible containers: 2 pieces GFJ-S (6) o-rings are used.

Containers with unparallel sides: 2 pieces GFJ-K wedge washers (5) are used.

Introduce the multipoint probe into the packing gland.

When the measuring points are placed as wanted the finger nut (4) is fastened, so that the system is tight.

The container can now be filled, sealed and placed in a suitable position in the heating media. The probe is inserted into the container and tightened with the protection tube (7). The SD4-probe is connected to 4 input sockets on the Ellab instruments used.

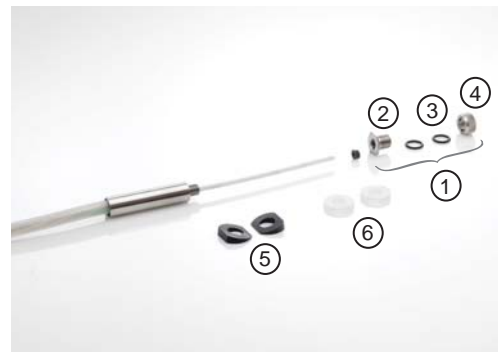

Configuration

SSA12xxxE700TS Probe

- ① GFJ-36009C-000 Packing gland
- ⑦ GFK-95012M-050 Protection tube

Spare part list

- ④ GKJ-J Finger nut
- ③ GFJ-U O-rings

Optional parts for very thin flexible containers:

- ⑥ GFK-S Silicone rubber washer

Optional parts for containers with unparallel sides:

- ⑤ GFJ-K Wedge washer

Other parts:

- TC89 Can punch
- TC40/41 Perforation tool
- TC42 Cutting tool

When ordering sensors, packing glands and space bars please replace xxx with the length(s) needed.

Real time container deflection with E-Val Flex



Deflection measurement

The deflection measurement system is able to measure the plus/minus deflections of the container during the thermal process.

With the deflection measurements it is now possible to establish the process parameters so that flexible and semi-rigid containers can be processed with minimal mechanical stress and deformation.

A container holding device (1) is manufactured according to the type and size of the container, and for this purpose a sample of the container(s) has to be sent to Ellab.

The container is fixed with a stainless steel plate, and the holding device is fastened with four screws, so it will not move around during processing.

The SHD stainless steel support (2) is positioned on top of the holding device, so the clamp (3) is positioned at the spot wanted, and then fastened with four screws.

For plastic trays, holding devices are available with up to three measuring points – top, bottom and side – for establishing the most optimal process parameters.

The LVDT deflection transducer (4) is then introduced into the autoclave chamber and position in the SHD stainless steel support, and the complete device is positioned at the spot wanted.

The LVDT deflection transducer cable is then connected to a D-Flex module (5) which again is connected to the RS485 port at the E-Val Flex master module.

By using a multibox it is possible to monitor deflection, autoclave pressure and container pressure using the RS485 port on the E-Val Flex master module. These parameters will then be presented together with the temperatures in the same data sessions.

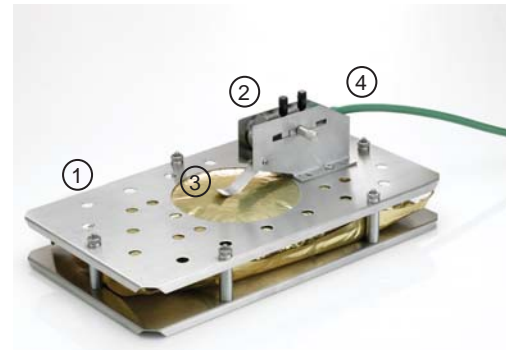

Configuration

E-Val Flex master module (please require documentation)

- ⑤ D-FLEX Module
- ④ LVDT Deflection transducer
- ② SHD Stainless steel support
- ① THD TRAY HOLDING Device (sample of container necessary)
 - GQJ16G12C001 Packing gland ½" or
 - GRJ19G34C001 Packing gland ¾" or
 - GSJ25G10C001 Packing gland 1"

Real time pressure with E-Val Flex



Container pressure

For pressure measurements in different containers the PRS digital pressure sensor and the PAJ connection system are needed.

Make a hole in the container with the can punch TC89 or TC40S/TC41 (see instructions for perforating and embossing the containers).

Introduce the pressure bushing (2) into the container and place the o-ring (3) on the bushing from the inside.

Screw on and fasten the fingernut (4) from the inside of the container.

The container can now be filled and sealed in the sealing machine also using vacuum.

The PAJ piercing needle (6) on the capillary tube is then inserted into the pressure bushing through a rubber seal so keeping an eventual vacuum.

The capillary tube is lead through the autoclave wall using an autoclave packing gland (7).

Using a syringe silicone oil (8) is injected into the capillary system in order to avoid air pockets.

On the outside of the autoclave the PRS digital pressure sensor is connected to the capillary tube, and the PRS is then connected to the RS485 of the E-Flex system.

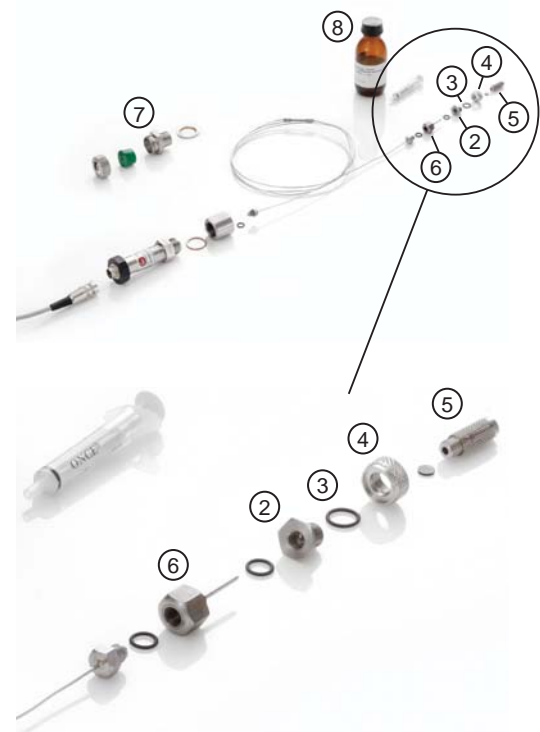

Autoclave pressure

For measurements of the autoclave pressure the PRS digital pressure sensor is needed. Range 0-4 bar. The PRS sensor can be mounted in a pocket of the autoclave, or by using a feed-trough which is available with 1/2", 3/4" or 1" which is screwed into the wall of the autoclave.

Configuration for container pressure

E-Val Flex Master module (please require documentation)
DIGITAL PRS SENSOR Digital pressure sensor
PRS O-RING O-ring for Digital pressure sensor
PAJDIGITALC030 Pressure connection kit for containers

- ⑦ GQJ16G12C001 Packing gland 1/2" or
- ⑦ GRJ19G34C001 Packing gland 3/4" or
- ⑦ GSJ25G10C001 Packing gland 1"

Configuration for autoclave pressure

DIGITAL PRS SENSOR Digital pressure sensor
PRS O-RING O-ring for Digital pressure sensor
FEED THROUGH 1", 3/4" or 1/2"
TRI CLAMP FLANGE 1", 3/4" or 1/2"

Real time rotation measurements with E-Val Flex



DCS-EL slipping contacts for measurements in rotating autoclaves

For measurements in rotating autoclaves we have developed a selection of slipping contacts which makes it possible to have real time data for temperature, pressure, deflection and rotation per minute during processing.

The slipping contact consists of a rotating part which is furnished with probe sockets and a 8mmØ locking screw for mounting, and the stationary part furnished with extension cables and a nylon bar to prevent rotation.

A suitable connection piece is mounted on the drive shaft of the autoclave in which the rotating part of the DCS slipping contact is fixed by using the locking screw.

The nylon bar on the stationary part is fixed so it is preventing rotation of the stationary part during processing.

The temperature probes are positioned in the probe sockets on the rotating part and led through the drive shaft via an autoclave packing gland.

The temperature extension cables are connected to the probe input sockets of the E-Val Flex module.

Rotation per minute cable (if applicable) is connected to the R-FLEX module which is connected to the RS485 port of the E-Val Flex module.

Deflection can be measured by mounting the DA26 kit with connection to a LVDT transducer on the rotating part. Two temperature input sockets are used to transmit data from one deflection channel, and the LVDT deflection cable are led through an autoclave packing gland positioned in the drive shaft. The deflection extension cable is then connected to a D-Flex module which is connected to the RS485 port at the E-Val Flex module.



Configuration

Temperature

DCS-4EL Slipping contact, 4 channels & RpM
DCS-8EL Slipping contact, 8 channels & RpM
DCS-16EL Slipping contact, 16 channels & RpM
GQJ16G12C001 Packing gland ½" or
GRJ19G34C001 Packing gland ¾" or
GSJ25G10C001 Packing gland 1"

Deflection

DA26 Kit
D-FLEX Module
SHD Support
THD Device

Rotation

R-FLEX Module

Container pressure with TrackSense® Pro



External mounting

Packing gland type PAJ Pro Pressure Pressure connection system for TrackSense® Pro Pressure

Make a hole (1) in the container with the can punch TC89 or TC40S/TC41 (see instructions for perforating and embossing the containers).

Disassemble the PAJ Pro pressure connection system.

Introduce the bushing (2) with the filter mesh (5) into the container.

Place the o-ring (3) on the bushing (2) from the inside.

Screw and fasten the fingernut (4) from the inside of the container.

The container can now be filled and sealed in the sealing machine.

The top nut of the pressure sensor is unscrewed and replaced with the following:

The top nut with piercing needle (6) is filled with silicone oil and screwed on top of the logger unit.

The logger and pressure sensor is started up in the reader station.

The piercing needle (6) is introduced into the PAJ packing gland and tightened by hand.

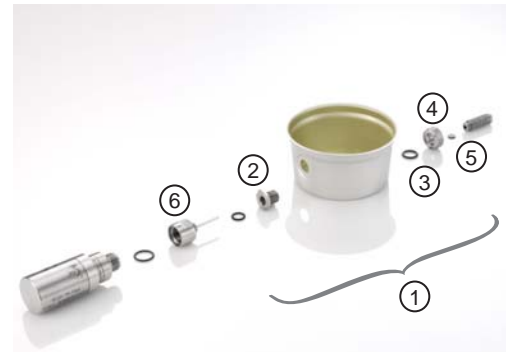

Configuration

TSPRO PRS Pressure sensors

① PAJ Pro pressure kit

Spare parts list

② PAJ Bushing with 9mmØ thread

③ GKJ-U O-ring

④ GKJ-J Stainless steel finger nut

⑤ PAJ Filter mesh

When ordering sensors, packing glands and space bars please replace xxx with the length(s) needed.

Temperature and Relative Humidity (RH%) in Smokehouses with TrackSense® Pro



For measurements in batch and continuous smokehouses we have developed the TS Fixture for holding a TrackSense® Pro logger, and a plastic water reservoir.

The TrackSense® Pro logger is furnished with a special RH PRO DW rigid double dry and wet double sensor, and the relative humidity is measured psychrometrically.

On the wet sensor is positioned a cotton sock which is immersed into the water reservoir (wet), and the other sensor is measuring the ambient temperature of the chamber (dry).

Using the dry and wet temperature measurements the ValSuite™ software is then automatically calculating the relative humidity (RH%) of the chamber, which is a very important parameter for the effect of the smoking process.



Configuration

TSP Logger

RH PRO DW Double temperature dry & wet sensor

TS FIXTURE for logger and water reservoir

RESERVOIR doe dry & wet measurements



Internal fittings

TSK/TSJ

The mini and micro loggers are designed for applications where size is an issue. The low volume displacement makes these small loggers ideal for monitoring inside of packaging.

Temperature in all kinds of containers

Cans, jars, trays, bottles, pouches, doy-packs, retortable cartons etc.

Internal fittings for wireless dataloggers

Make a hole in the container with the can punch TC89 or TC40S/TC41 or TC42 (see instructions for perforating and embossing the containers).

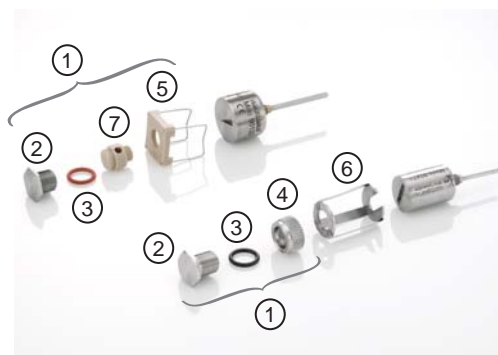

Disassemble the TSK/TSJ Fixture (1).

Introduce the screw (2) into the hole and place the o-ring (3) on the screw from the inside of the container.

Screw on and fasten the fixture (5 or 6) from the inside of the container – or if the measuring depth has to be adjusted the screw (2) and o-ring (3) is tightened with the finger nut (4) and TSK distance piece (7) is screwed into the inner thread of the screw securing measurements in the “cold spot”. The fixture (5 or 6) is screwed on the distance piece.

The logger is started up in the reader station and then placed in the fixture inside the container.

The container can now be filled and sealed, and if a mixed product the part with the slowest heat transfer can be positioned at the measuring points (meat balls, fish etc.).

Configuration

Mini logger

- ① TSK MINI Fixture
- ⑦ TSK10PROL0xx Distance piece (opt)

Micro logger

- TSJ MICRO TMP Fixture
- TKK10PROL0xx Distance piece (opt)

TSPro logger

- TSJ08000Q054 Fixture
- TKK10PROL0xx Distance piece (opt)

Spare parts list

- | | | |
|--------------------|------------------|------------------|
| ② TSK Screw 9mmØ | TSJ Screw 9mmØ | TSJ Screw 9mmØ |
| ③ GKJ-U O-ring | GKJ-U O-ring | GKJ-U O-ring |
| ④ GKJ-J Finger nut | GKJ-K Finger nut | GKJ-J Finger nut |

When ordering sensors, packing glands and space bars please replace xxx with the length(s) needed.

Internal temperature fittings for cans, jars, trays, bottles, retortable cartons



TBJ stainless steel frame for bottles, cans, jars, trays RECART stainless steel frame for retortable cartons

A stainless steel frame (1) is manufactured exactly for the dimensions of the container. The frame is furnished with a nut (2) with internal thread.

The logger is started up in the reader station and then placed in the fixture (3, 4 or 5).

The fixture with the logger is then screwed into the nut (2) of the frame (1).

If the measuring depth has to be adjusted a TTK distance piece (6) is screwed in between the frame and the fixture securing measurements in the “cold spot”.

The whole assembly is then immersed into the container.

The container can now be filled and sealed, and if a mixed product the part with the slowest heat transfer can be positioned at the measuring points (meat balls, fish etc.).

This application has the advantage that it is not necessary to make any holes in the container, maintaining the container integrity during processing.

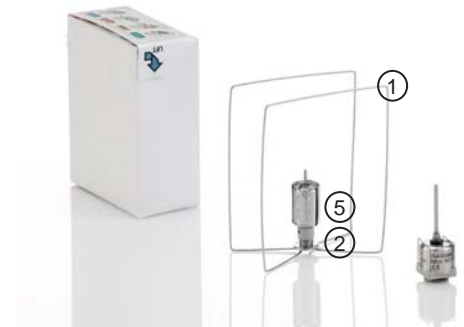

Configuration

Mini logger

- ① TBJ Frame/ RECART Frame
- ④ TSK MINI Fixture
- ⑥ TTK10PROL0xx Distance piece (opt)

Micro logger

- TBJ Frame/ RECART Frame
- TSJ MICRO TMP Fixture
- TKK10PROL0xx Distance piece (opt)

TSPro logger

- TBJ Frame/ RECART Frame
- TSJ08000Q054 Fixture
- TKK10PROL0xx Distance piece (opt)

Spare parts list

- | | | |
|--------------------|------------------|------------------|
| TSK Screw 9mmØ | TSJ Screw 9mmØ | TSJ Screw 9mmØ |
| GKJ-U O-ring | GKJ-U O-ring | GKJ-U O-ring |
| ② GKJ-J Finger nut | GKJ-K Finger nut | GKJ-J Finger nut |

When ordering sensors, packing glands and space bars please replace xxx with the length(s) needed.

Internal temperature fittings for flat pouches and doypacks

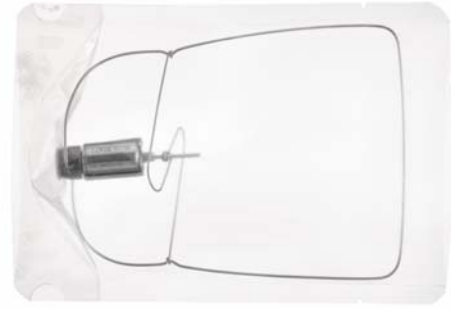

TPJ stainless steel frame for flat pouches TDJ stainless steel frame for stand-up pouches

A stainless steel frame (1) is manufactured exactly for the dimensions of the pouch. The frame is furnished with a nut (2) with internal thread.

The wire is bended so it is fitting the bottom of the pouch.

The frame is in the middle furnished with a “crossing wire” (3) fitting the thickness of the pouch for fixating the sensor, and thus avoiding movement of the sensor touching the wall of the pouch.

The logger is started up in the reader station and then placed in the fixture (4).

The fixture with the logger is then screwed into the nut (2) of the frame (1) using the TSK screw (6) and O-ring (7) and the sensor fixated in the hole of the crossing wire (3). If the measuring depth has to be adjusted a TSK distance piece (5) is screwed in between the frame and the fixture securing measurements in the “cold spot”.

The whole assembly is then immersed into the pouch.

The container can now be filled and sealed, and if a mixed product the part with the slowest heat transfer can be positioned at the measuring points (meat balls, fish etc.).

This application has the advantage that it is not necessary to make any holes in the container, maintaining the container integrity during processing.

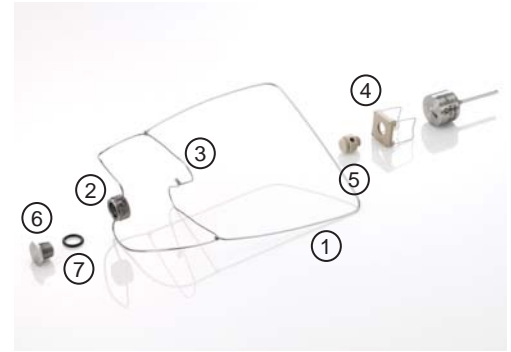

Configuration

Mini logger

- ① TPJ Pouch frame/ TDJ Doypack frame
- ④ TSK MINI Fixture
- ⑤ TSK10PROL0xx Distance piece (opt)

Micro logger

- ① TPJ Pouch frame/ TDJ Doypack frame
- ④ TSJ MICRO TMP Fixture
- ⑤ TSK10PROL0xx Distance piece (opt)

TSPro logger

- ① TPJ Pouch frame/ TDJ Doypack frame
- ④ TSJ08000Q054 Fixture
- ⑤ TSK10PROL0xx Distance piece (opt)

Spare parts list

- | | | |
|------------------|----------------|----------------|
| ⑥ TSK Screw 9mmØ | TSJ Screw 9mmØ | TSJ Screw 9mmØ |
| ⑦ GKJ-U O-ring | GKJ-U O-ring | GKJ-U O-ring |

When ordering sensors, packing glands and space bars please replace xxx with the length(s) needed.

Internal pressure fittings for all kinds of containers, cans, jars, trays, bottles, retortable cartons, doypacks and pouches



Internal fittings for pressure dataloggers

Make a hole in the container with the can punch TC89 or TC40S/TC41 or TC42 (see instructions for perforating and embossing the containers).

Introduce the screw into the hole and place the o-ring on the screw from the inside of the container.

Screw on and fasten the fixture (3) from the inside of the container.

The logger is started up in the reader station and then placed in the fixture (4) inside the container.

The container can now be filled and sealed.



Configuration

Micro PRS Logger

TSJ MICRO PRS/TMP Fixture

Micro PRS/TMP Logger

TSJ MICRO PRS/TMP Fixture

TSPPro Pressure sensors

TSK08000Q001 Fixture

Spare parts list

② TSJ Screw 9mmØ	TSJ Screw 9mmØ	TSJ Screw 9mmØ
③ GKJ-U O-ring	GKJ-U O-ring	GKJ-U O-ring
④ GKJ-J Finger nut	GKJ-K Finger nut	GKJ-J Finger nut

Internal fitting for micro pressure and micro pressure/temperature loggers

Both loggers are started up in the reader station.

A hole is punched in the top or bottom of the can and the external pressure sensor is fixed with a special nut and the logger is positioned in the plastic holder (3).

The internal pressure/(temperature) logger is also positioned in the plastic holder (3).

If used in continuous cooker/coolers secure that the can is balanced and freely rolling. The can can now be filled and sealed and ready for process.



Configuration

Micro pressure logger, 2 pieces

- ③ PRS-INT-EXT Internal/external fixture

Can rotation speed in continuous cooker-coolers and hydrostats



The number of rotations is a very important parameter for the effect of the heat penetration during the process.

It is therefore recommended frequently to check the number of rotations of the containers to secure that the product is achieving the proper heat treatment.

Internal fittings for micro rotation loggers

Make a hole in the container with the can punch TC89 or TC40S/TC41 or TC42 (see instructions for perforating and embossing the containers).

Disassemble the TSJ Fixture (1).

Introduce the screw (2) into the hole and place the o-ring (3) on the screw from the inside of the container.

Screw on and fasten the fixture (5) from the inside of the container using finger nut (4).

The logger is started up in the reader station and no programming is needed. The process results will be presented as rotation per sample, axial rotation direction and total rotations.

The logger is then placed in the fixture (5) inside the container.

The fixture has to be mounted axial to secure that the container is balanced and freely rolling.

The container can now be filled and sealed.



Configuration

TSP MICRO ROT Logger
TSJ MICRO ROT Fixture

Spare parts list

- ② TSJ Screw 9mmØ
- ③ GKJ-U O-ring
- ④ GKJ-J Finger nut

Instructions for perforating and embossing the containers



TC89 - Can punch

The TC89 is designed for perforation and embossing of all metal containers such as cans, alu-containers etc., and for perforation of plastic containers.

The profiled hole is fitting the GKJ-C and GTJ-C packing glands and other special glands with diameter of 9 mm.

Place a mark on the container where you want the packing gland to be fitted.

Place the container in the can punch so that the piston punch (2) will perforate exactly where you want it to.

The height/depth restrictor (3) can be locked at the distance wanted.

When the containers are correctly positioned press down the hand lever (4), and the piston punch will make a perfect hole (1).

Metal containers: continue to press until the profile is made. This is important for the tightness and for getting the container in the sealing machine with the gland fitted.

The container is now ready to be fitted with a packing gland. Please see instructions for same.

When you have finished please remember to remove the cut-outs (5) from the TC89.

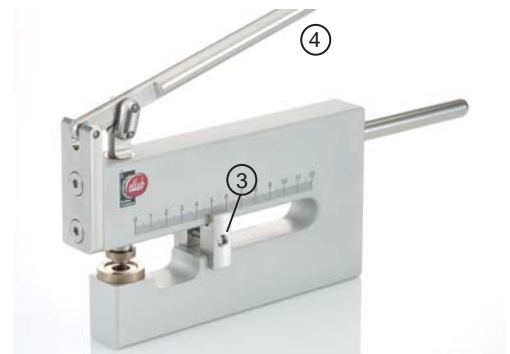

Instructions for perforating and embossing the containers



TC41 and TC40S - Perforation and pre-perforation tool

The TC40S is designed for perforation and embossing of alu- and plastcontainers.

The profiled hole is fitting the GKJ-C and GTJ-C packing glands with a diameter of 9 mm.

Make a mark on the container where you want the packing gland to be fitted and pre-perforate a hole (1) with the TC41 (2).

Disassemble the TC40S.

Introduce the allen screw (3) with the female bush (4) through the hole from the inside of the container.

Place the male bush (5) on the allen screw (3).

Screw on grip (7) and continue until a clean hole is made. Use allen tool (6) to counterbalance.

Alu-containers: keep on screwing until the profile is made. This is important for the tightness and for getting the container in the sealing machine, with the gland fitted.

The container is now ready to be fitted with a packing gland. Please see instructions for same.

When you have finished please remember to remove the cut-outs from the TC40S.



Instructions for perforating the containers



TC42 - Cutting tool

The TC42 is used for perforation of flexible plastic pouches.

The 8 mm diameter hole is fitting the GKJ-C and GTK-C packing glands. On request we can deliver tools with other diameters.

Place a mark on the container where you want the gland to be fitted.

Press the cutting tool either by hand or with a hammer until a hole is cut out.

When cutting the hole it is recommended to use a piece of wood as underlay.

The container can now be fitted with the glands needed.

On the right please find examples of flexible containers where these cutting tools have been used.

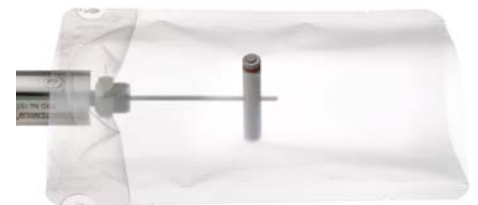
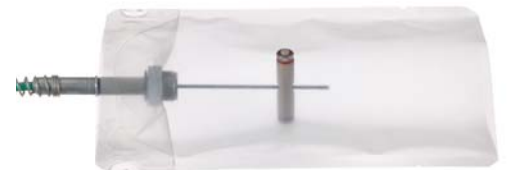

TC25 Cutting tool TC26 Spanner

These tools are used with the HUU packing gland and in already filled metal containers. It can be used in some plastic containers if the thickness of the container is thick enough for fastening.

Make a hole in the container with the TC25 perforation tool (2) and a hammer.

Place the HUU-C (3) in the TC26 spanner (4) and screw it into the hole.

Screw until it is tight, but be careful not to screw too tight.

Use the TTK distance piece (5) if necessary.

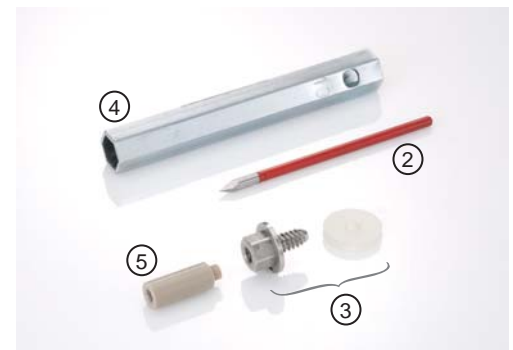

Protective sleeves for the TrackSense® Pro Loggers



If needed the loggers can be protected with a rubber protective sleeve in which the loggers can be easily inserted.

The rubber sleeves can also be useful for different applications where the loggers are to be hung on a string in different positions. Examples of this are the validation of empty autoclaves, warehouses, bulk products, etc.



Configuration

TSP 2 mm
TSS25044S

TSP Mini
TSS20016S

TSP Micro
TSS16022S

ID labels for Ellab thermocouples and TrackSense® Pro sensors



For easy and fast identification of thermocouples and logger sensors, the color coded ID labels are a very convenient tool.

The ID labels are made from shrink tube polyolefin and can easily be placed on Ellab type STC thermocouples and TrackSense® Pro sensors with diameter of 1.6 to 3.2 mm using a hot air blower (~90°C). The operating temperature range is from -55°C to +200°C.

Configuration

ID-Labels 25105998 – set of 1-16 orange with black text

ID-Labels 25105999 – set of 1-16 yellow with black text

Ellab



ELLAB A/S
Kronalvej 9
DK-2610 Roedovre
Denmark
Phone: +45 4452 0500
Fax: +45 4453 0505
E-mail: info@ellab.com

Thermal Validation Solutions



www.ellab.com

ELLAB Inc.
6551 South Revere Parkway
Suite 145
Centennial, CO 80111
USA
Phone: 303 425 3370
Fax: 303 425 3384
E-mail: usa@ellab.com

ELLAB GmbH
An der Autobahn 5
D-27404 Bockel
Germany
Phone: 04286 92662-0
Fax: 04286 92662-66
E-mail: germany@ellab.com

ELLAB UK LTD.
3 Lodge Farm Barns
New Road, Bawburgh
Norwich
Norfolk NR9 3LZ
United Kingdom
Phone: 01603 743724
Fax: 01603 740118
E-mail: uk@ellab.com

ELLAB S.A.R.L.
ZAC de Mercières
5 Ter, rue Clément Ader
2e étage
60200 Compiègne
France
Phone: 0344 2302 57
Fax: 0344 2308 94
E-mail: france@ellab.com

ELLAB Philippines Corp.
4810-B Sampaguita
St. Marimar I
Bicutan
Paranaque City
Philippines
Phone: 02787 8258
Fax: 02824 7924
E-mail: ph@ellab.com